

# TECHNICAL DATA

Three Phase Electric Motors - Cast Iron Frame  
 PE30 112 M 4 IE3  
 4 kW / 5.5 Cv  
 1460 RPM

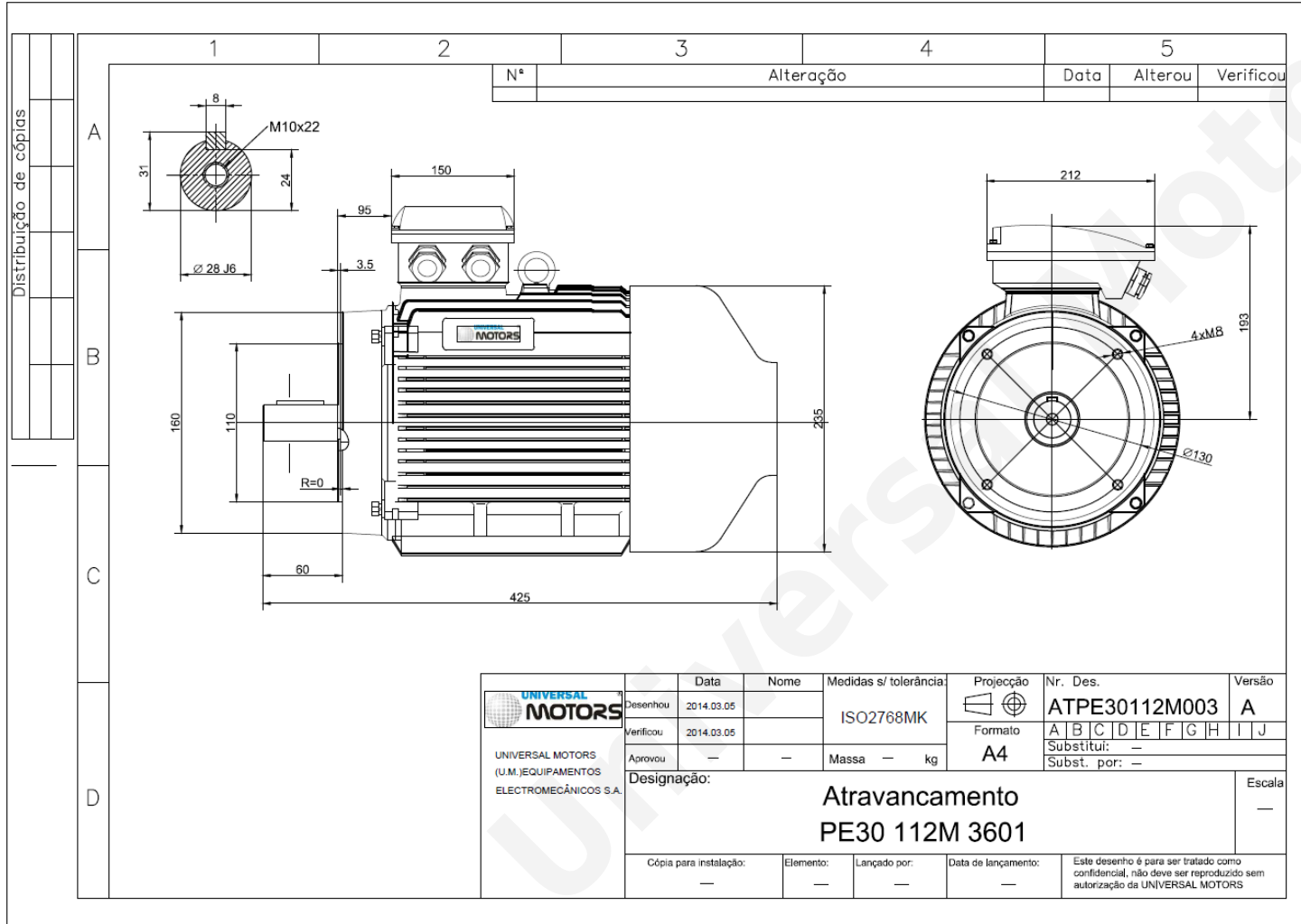

Motor type: **PE30 112 M 4 IE3**  
 Output: **4 kW / 5.5 Cv**  
 Speed (min<sup>-1</sup>): **1460 RPM**  
 Frequency: **50 Hz**  
 Voltage: **400 V**  
 Current: **7.95 A**  
 Power factor (Cos Ø): **0.82**  
 Poles: **4**  
 Insulation class: **F**  
 Temperature rise Class: **B**  
 Efficiency 50%: **87.9 %**  
 Efficiency 75%: **89.4 %**  
 Efficiency 100%: **88.7 %**  
 Torque: **26 N.m**  
 Tstarting/Tnominal: **2.2**  
 Istarting/Inominal: **7.8**  
 Tmaximum/Tnominal: **2.3**  
 Noise: **54 Db(A)**  
 Weight: **61 Kg**  
 Bearing DE: **6306 2Z C3**  
 Bearing NDE: **6306 2Z C3**

Regime - S1

Altitude - 1000m

Environment Temperature - 40°C

## CONTACTS:

UNIVERSAL MOTORS Tel: +351 252 299 080  
 Rua de São Brás,745 Fax: +351 252 299 089  
 4480-782 VILA DO CONDE Mail: [geral@universalmotors.pt](mailto:geral@universalmotors.pt)

\* References applied only in the UK